

3 Stereo Inputs and 4-Channel Outputs Volume, Tone, Balance, Fader, Loudness, and Selectable Input Gain

FEATURES

- Operation range : 2.7V~6.5V
- 3 stereo inputs with selectable input gain
- 4 independent speaker controls for fader and balance
- Tone controls (treble and bass) and loudness function
- Independent mute function
- Volume control in 1.25 dB/step
- I²C interface
- Components less and good PSRR
- Housed in SSOP28 packages

APPLICATIONS

- Portable audio device
- Car stereo audio
- Hi-Fi audio system
- Cross-reference:
TDA7313

DESCRIPTION

The MS6713 is a 3 stereo inputs/4-channel outputs digital control audio processor for the low voltage operation. Volume, tone (bass and treble), balance (left/right), and fader (front/rear) processor are incorporated into a single chip. The MS6713 also has the loudness function and selectable input gain. These functions can be built a Hi-Fi audio system easily. All functions are programmable via the serial I²C bus. The default states of the chip as the power is on are: the volume is -78.75dB, the stereo 4 is selected, all the speakers are mute and the gains of the input stage, the bass and the treble are 0dB. The stereo 4 is connected internally, but not available on pins.

BLOCK DIAGRAM

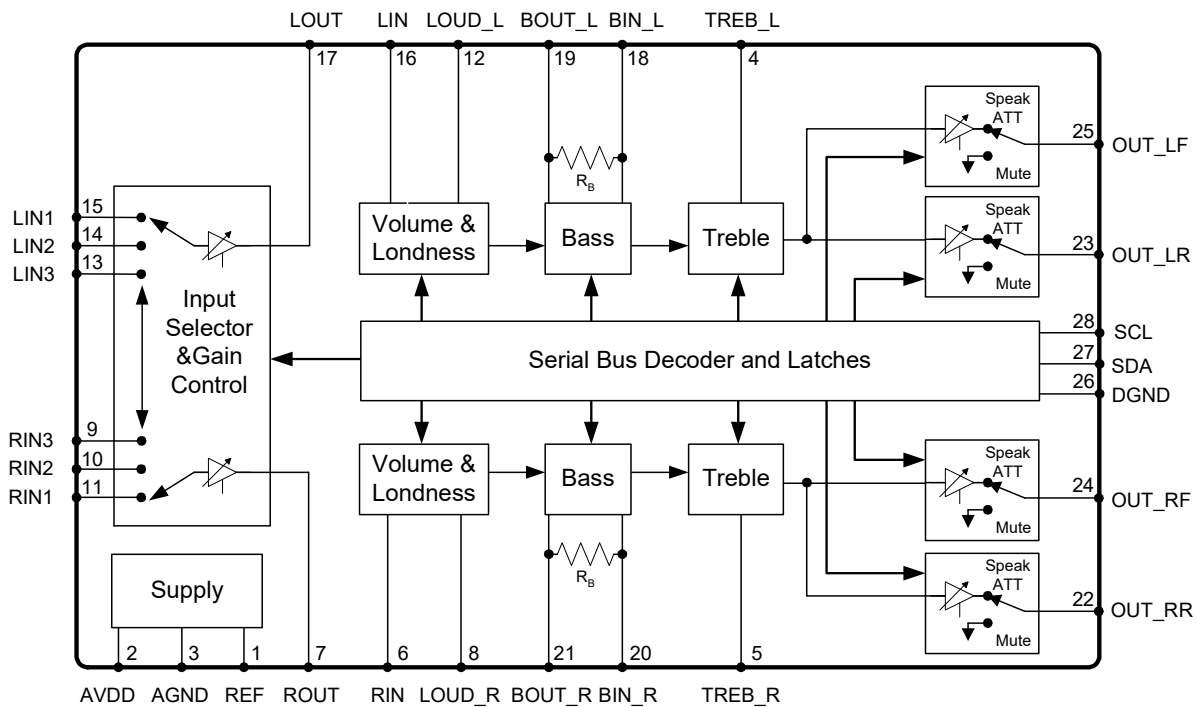

PIN CONFIGURATION

Symbol	Pin	Description
REF	1	Analog Reference Voltage (1/2VDD)
VDD	2	Supply Input Voltage
AGND	3	Analog Ground
TREB_L	4	Left Channel Input for Treble Controller
TREB_R	5	Right Channel Input for Treble Controller
RIN	6	Audio Processor Right Channel Input
ROUT	7	Gain Output and Input Selector for Right Channel
LOUD_R	8	Right Channel Loudness Input
RIN3	9	Right Channel Input 3
RIN2	10	Right Channel Input 2
RIN1	11	Right Channel Input 1
LOUD_L	12	Left Channel Loudness Input
LIN3	13	Left Channel Input 3
LIN2	14	Left Channel Input 2
LIN1	15	Left Channel Input 1
LIN	16	Audio Processor Left Channel Input
LOUT	17	Gain Output and Input Selector for Left Channel
BIN_L	18	Left Bass Controller Input Channel
BOUT_L	19	Left Bass Controller Output Channel
BIN_R	20	Right Bass Controller Input Channel
BOUT_R	21	Right Bass Controller Output Channel
OUT_RR	22	Right Rear Speaker Output
OUT_LR	23	Left Rear Speaker Output
OUT_RF	24	Right Front Speaker Output
OUT_LF	25	Left Front Speaker Output
DGND	26	Digital Ground
SDA	27	I ² C Data Input
SCL	28	I ² C Clock Input

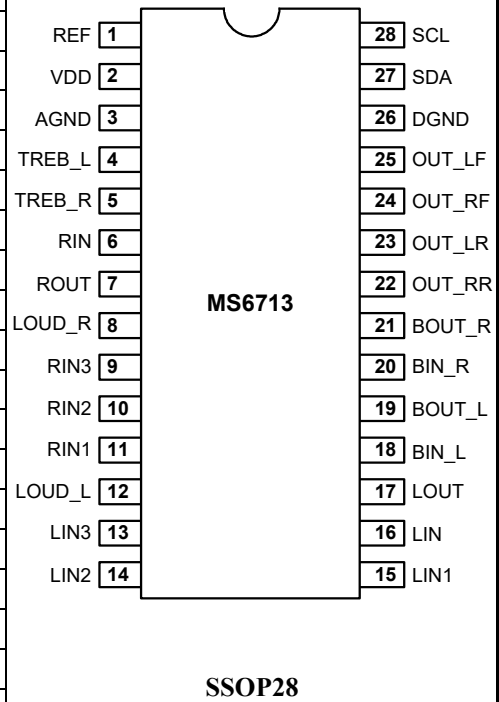

ORDERING INFORMATION

Package	Part number	Packaging Marking	Transport Media
28-Pin SSOP (lead free)	MS6713SSGTR	MS6713G	2.5k Units Tape and Reel
28-Pin SSOP (lead free)	MS6713SSGU	MS6713G	50 Units Tube

ABSOLUTE MAXIMUM RATINGS

Symbol	Parameter	Rating	Unit
V _{DD}	Supply Voltage	6.5	V
V _{ESD}	Electrostatic Handling	-3000 to 3000	V
T _{STG}	Storage Temperature Range	-65 to 150	°C
T _A	Operating Ambient Temperature Range	-40 to 85	°C
T _J	Maximum Junction Temperature	150	°C
T _S	Soldering Temperature, 10 seconds	260	°C
R _{THJA}	Thermal Resistance from Junction to Ambient in Free Air SSOP28	210	°C/W

OPERATING RATINGS

Symbol	Parameter	Min	Typ	Max	Unit
V _{DD}	Supply Voltage	2.7	-	6.5	V

5V ELECTRICAL CHARACTERISTICS

(Ta=25°C, All stages 0dB, f=1kHz, C_{REF} =22uF, refer to the application circuit; unless otherwise specified)

Symbol	Parameter	Conditions	Min	Typ	Max	Unit
Supply						
I _Q	Quiescent Current	V _{IN} =0V	-	12.2	12.5	mA
PSRR	Power Supply Rejection Ratio	C _{REF} = 22uF, f = 100Hz	55	60	-	dB
Input Selectors						
R _{IN}	Input Resistance	Input 1,2,3	35	50	70	kΩ
G _{IN}	Input Gain Range	Gain	0	-	11.25	dB
G _{STEP}	Step Resolution		-	3.75	-	dB
ERR _G	Gain Setting error		-0.2	0	0.2	dB
LOUD	Loudness	C _{Loud} =100nF, f =20Hz Volume=-40dB	19	20	-	dB
Volume control						
CR _{VOL}	Volume Control Range	Attenuation	-78.75	-	0	dB
RES _{VOL}	Volume Step Resolution		-	1.25	-	dB
ERR _{VOL}	Volume Setting Error	Av = 0 to -40dB	-0.5	0	1	dB
		Av = -40 to -60dB	-1	0	5	dB
Speaker Attenuators						
CR _{SPK}	Speaker Control Range	Attenuation	-37.5	-	0	dB
RES _{SPK}	Speaker Step Resolution		-	1.25	-	dB
ERR _{SPK}	Speaker Setting Error		-0.2	0	0.1	dB
MUTE	Output Mute Attenuation		-	-65	-60	dB
Bass Control						
CR _{BAS}	Bass Control Range	Boost/Cut	-14	-	14	dB
RES _{BAS}	Bass Step Resolution		-	2	-	dB
ERR _{BAS}	Speaker Setting Error	f =100Hz	-0.3	0	0.1	dB
R _B	Internal Feedback Resistance		34	44	58	kΩ
Treble Control						
CR _{BAS}	Treble Control Range	Boost/Cut	-14	-	14	dB
RES _{BAS}	Treble Step Resolution		-	2	-	dB
ERR _{BAS}	Treble Setting Error	f =20kHz	-0.3	0	0.1	dB
General						
VO _{MAX}	Maximum Output Voltage Swing	(THD+N)/S <0.3%	-	4.5	-	V _{pp}
THD+N	Total Harmonic Distortion Plus Noise	V _{OUT} =2V _{pp}	-	-75	-	dB
			-	0.0177	-	%
S/N	Signal-to-Noise Ratio	V _{OUT} =4V _{pp}	-	97	-	dB
CS	Channel Separation Left/Right		93	97	-	dB
Bus Input						
V _{IH}	Bus High Input Level		2	-	-	V
V _{IL}	Bus Low Input Level		-	-	0.8	V

Notes : Bass and Treble response see to curve. The center frequency and quality of the response behavior can be chosen by the external.

2.7V ELECTRICAL CHARACTERISTICS

(Ta=25°C, All stages 0dB, f=1kHz, C_{REF} =22uF, refer to the application circuit; unless otherwise specified)

Symbol	Parameter	Conditions	Min	Typ	Max	Unit
Supply						
I _Q	Quiescent Current	V _{IN} =0V	-	8.7	9	mA
PSRR	Power Supply Rejection Ratio	C _{REF} = 22uF, f = 100Hz	53	58	-	dB
General						
V _O MAX	Maximum Output Voltage Swing	(THD+N)/S <0.3%	-	2.5	-	V _{pp}
THD+N	Total Harmonic Distortion Plus Noise	V _{OUT} =2V _{pp}	-	-50	-	dB
			-	0.3	-	%
S/N	Signal-to-Noise Ratio	V _{OUT} =2.5V _{pp}	90	94	-	dB
CS	Channel Separation Left/Right		90	94	-	dB

TYPICAL PERFORMANCE CHARACTERISTICS

(Ta=25°C, All stages 0dB, f=1kHz, C_{REF} =22uF, refer to the application circuit; unless otherwise specified)

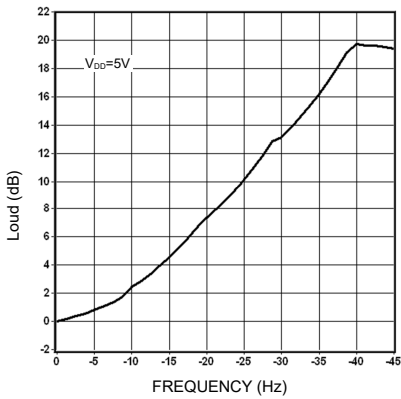

Loudness vs. Volume

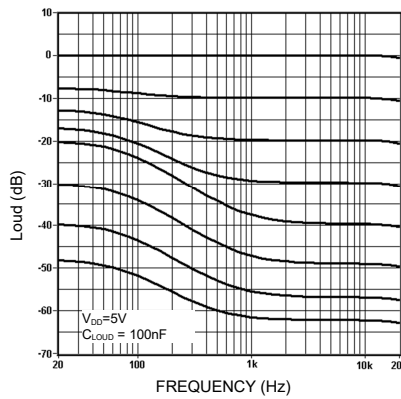

Loudness vs. Frequency vs. Volume

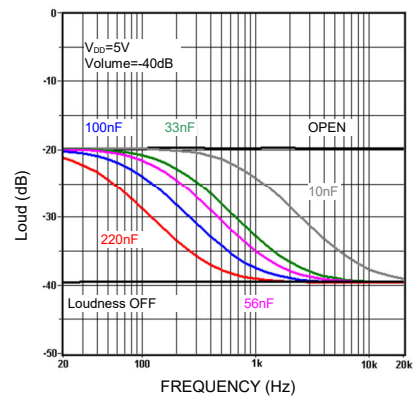

Loudness vs. External Capacitors

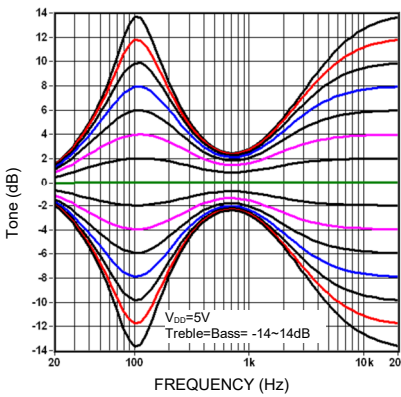

Typical Tone Response

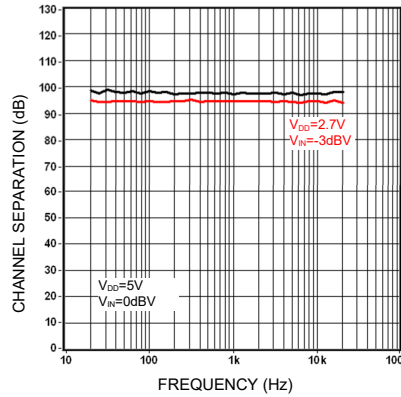

Channel Separation vs. Frequency

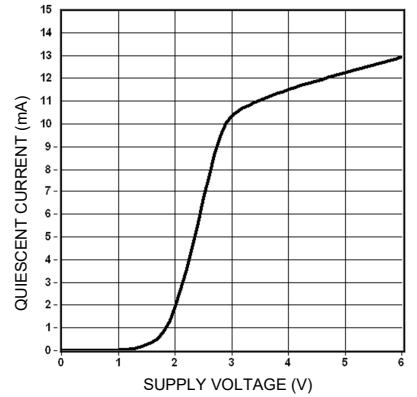

Quiescent Current vs. Supply Voltage

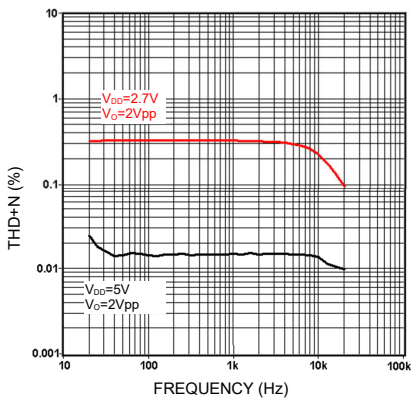

THD+N vs. Frequency

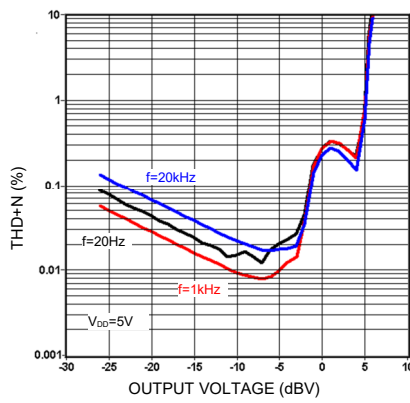

THD+N vs. Output Voltage

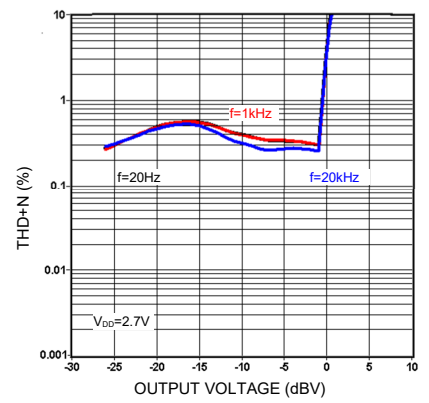

THD+N vs. Output Voltage

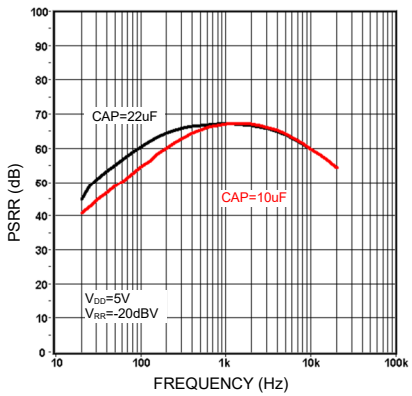

PSRR vs. Frequency

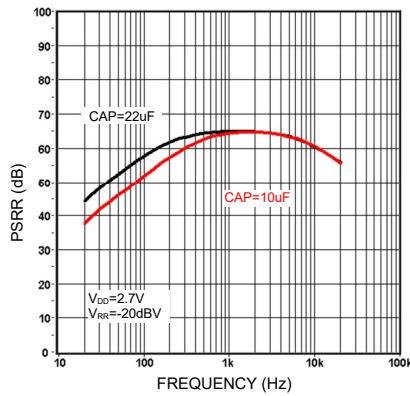

PSRR vs. Frequency

I²C BUS DESCRIPTION

Start and Stop Conditions

A start condition is activated when the SCL is set to HIGH and SDA shifts from HIGH to LOW state. The stop condition is activated when SCL is set to HIGH and SDA shifts from LOW to HIGH state. Please refer to the timing diagram below.

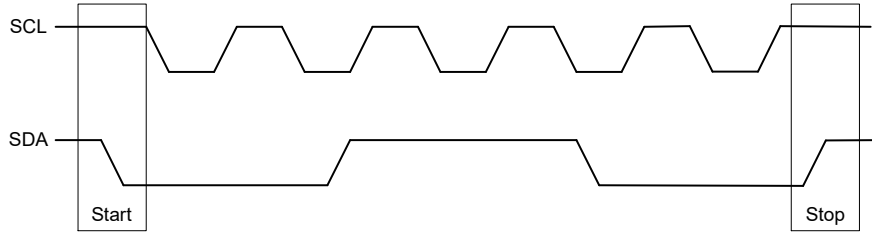

SCL : Serial Clock Line, SDA : Serial Data Line

Data Validity

A data on the SDA line is considered valid and stable only when the SCL signal is in HIGH state. The HIGH and LOW states of the SDA line can only change when the SCL signal is LOW. Please refer to the figure below.

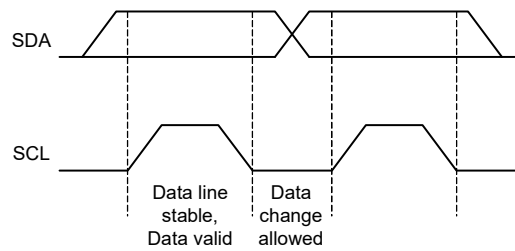

Byte Format

Every byte transmitted to the SDA line consists of 8 bits. Each byte must be followed by an acknowledge bit. The MSB is transmitted first.

Acknowledge

During the Acknowledge clock pulse, the master (up) put a resistive HIGH level on the SDA line. The peripheral (audio processor) that acknowledges has to pull-down (LOW) the SDA line during the Acknowledge clock pulse so that the SDA line is in a stable LOW state during this clock pulse. Please refer to the diagram below.

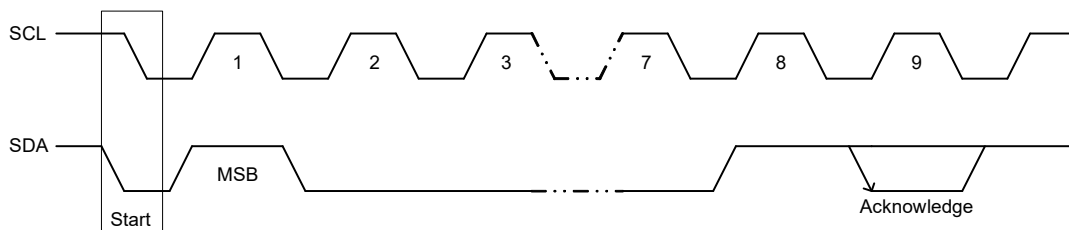

The audio processor that has been addressed has to generate an Acknowledge after receiving each byte, otherwise, the SDA line will remain at the HIGH level during the ninth (9th) clock pulse. In this case, the master transmitter can generate the STOP information in order to abort the transfer.

Timing of SDA and SCL Bus Lines

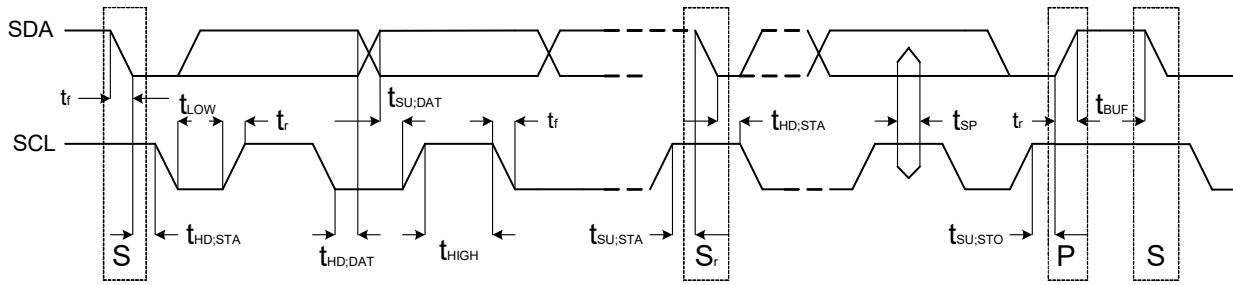

Standard Mode

Symbol	Parameter	Min	Max	Unit
f_{SCL}	SCL clock frequency	0	100	kHz
$t_{HD:STA}$	Hold time (repeated) START condition. After this period, the first clock pulse is generated	4.0	-	us
t_{LOW}	LOW period of the SCL clock	4.7	-	us
t_{HIGH}	HIGH period of the SCL clock	4.0	-	us
$t_{SU:STA}$	Set-up time for a repeated START condition	4.7	-	us
$t_{HD:DAT}$	Data hold time: For I ² C-bus devices	0	3.45	us
$t_{SU:DAT}$	Data-set-up time	250	-	ns
t_r	Rise time of both SDA and SCL signals	-	1000	ns
t_f	Fall time of both SDA and SCL signals	-	300	ns
$t_{SU:STO}$	Set-up time for STOP condition	4.0	-	us
t_{BUF}	Bus free time between a STOP and START condition	4.7	-	us
C_b	Capacitive load for each bus line	-	400	pF
V_{nL}	Noise margin at the LOW level for each connected device (including hysteresis)	$0.1V_{DD}$	-	V
V_{nH}	Noise margin at the HIGH level for each connected device (including hysteresis)	$0.2V_{DD}$	-	V

BUS INTERFACE

Data are transmitted to and from the MCU to the MS6713 via the SDA and SCL. The SDA and SCL make up the BUS interface. It should be noted that pull-up resistors must be connected to the positive supply voltage.

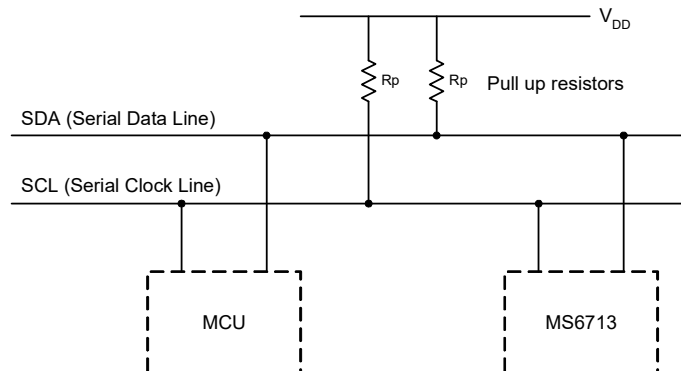

Interface Protocol

The format consists of the following

- A START condition
- A chip address byte including the MS6713 address. (7bits)
- The 8th bit of the byte must be “0”.(write)
- MS6713 must always acknowledge the end of each transmitted byte.
- A data sequence (N-bytes + Acknowledge)
- A STOP condition

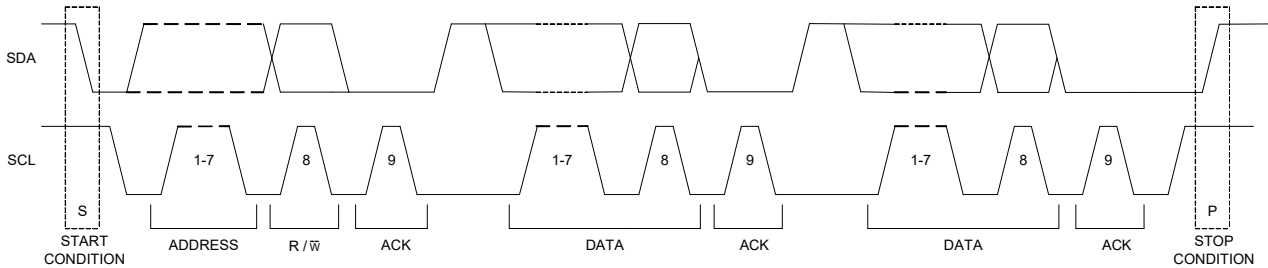

Address Code

The chip address of the MS6713 is 88H.

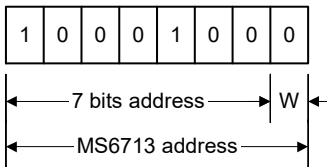

Data Bytes Description

The default states of the chip as the power is on are: the volume is -78.75dB, the stereo 4 is selected, all the speakers are mute and the gains of the input stage, the bass and the treble are 0dB. The stereo 4 is connected internally, but not available on pins.

MSB				LSB				Function
0	0	B2	B1	B0	A2	A1	A0	Volume Control
1	1	0	B1	B0	A2	A1	A0	Speaker ATT LR
1	1	1	B1	B0	A2	A1	A0	Speaker ATT RR
1	0	0	B1	B0	A2	A1	A0	Speaker ATT LF
1	0	1	B1	B0	A2	A1	A0	Speaker ATT RF
0	1	0	G1	G0	S2	S1	S0	Audio Switch
0	1	1	0	C3	C2	C1	C0	Bass Control
0	1	1	1	C3	C2	C1	C0	Treble Control

Where Ax = 1.25dB/step; Bx = 10dB/step; Cx = 2dB/step; Gx = 3.75dB/step

Volume

MSB					LSB			Function
0	0	B2	B1	B0	A2	A1	A0	Volume 1.25 dB steps
					0	0	0	0
					0	0	1	-1.25
					0	1	0	-2.5
					0	1	1	-3.75
					1	0	0	-5
					1	0	1	-6.25
					1	1	0	-7.5
					1	1	1	-8.75
0	0	B2	B1	B0	A2	A1	A0	Volume 10dB steps
		0	0	0				0
		0	0	1				-10
		0	1	0				-20
		0	1	1				-30
		1	0	0				-40
		1	0	1				-50
		1	1	0				-60
		1	1	1				-70

The default volume is -78.75dB.

Speaker Attenuator

MSB					LSB			Function (dB)
1	0	0	B1	B0	A2	A1	A0	Speaker LF
1	0	1	B1	B0	A2	A1	A0	Speaker RF
1	1	0	B1	B0	A2	A1	A0	Speaker LR
1	1	1	B1	B0	A2	A1	A0	Speaker RR
					0	0	0	0
					0	0	1	-1.25
					0	1	0	-2.5
					0	1	1	-3.75
					1	0	0	-5
					1	0	1	-6.25
					1	1	0	-7.5
					1	1	1	-8.75
			0	0				0
			0	1				-10
			1	0				-20
			1	1				-30
			1	1	1	1	1	Mute

LF: Left Front, RF: Right Front, LR: Left Rear, RR: Right Rear

The default state is mute.

Audio Switch

MSB				LSB				Function
0	1	0	G1	G0	S2	S1	S0	Audio Switch
						0	0	Stereo 1
						0	1	Stereo 2
						1	0	Stereo 3
						1	1	*Stereo 4
					0			Loudness ON
					1			Loudness OFF
			0	0				+11.25dB
			0	1				+7.5dB
			1	0				+3.75dB
			1	1				0dB

* The stereo 4 is connected internally, but not available on pins.
The default state is stereo 4, loudness off and gain 0dB.

Bass and Treble

MSB				LSB				Function (dB)
0	1	1	0	C3	C2	C1	C0	Bass
0	1	1	1	C3	C2	C1	C0	Treble
				0	0	0	0	-14
				0	0	0	1	-12
				0	0	1	0	-10
				0	0	1	1	-8
				0	1	0	0	-6
				0	1	0	1	-4
				0	1	1	0	-2
				0	1	1	1	0
				1	1	1	1	0
				1	1	1	0	2
				1	1	0	1	4
				1	1	0	0	6
				1	0	1	1	8
				1	0	1	0	10
				1	0	0	1	12
				1	0	0	0	14

The default state is bass 0dB and treble 0dB.

Examples

Set Volume at -37.5dB.

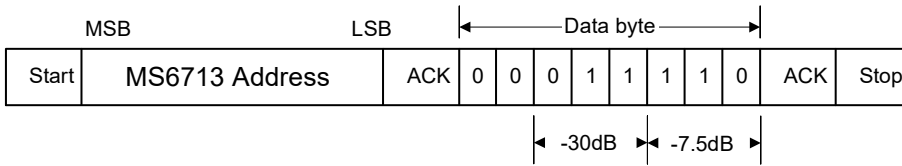

Set Speaker RF at -30dB.

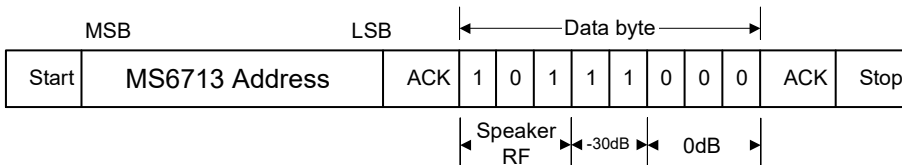

Set Speaker RR in mute-on.

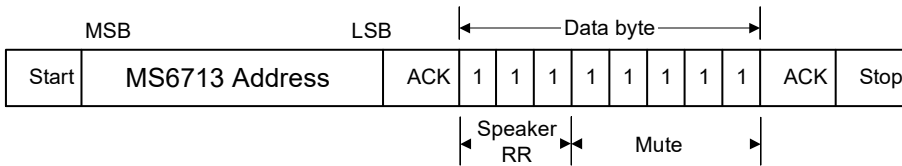

Set Stereo 2 Input with gain of +7.5 dB and Loudness on.

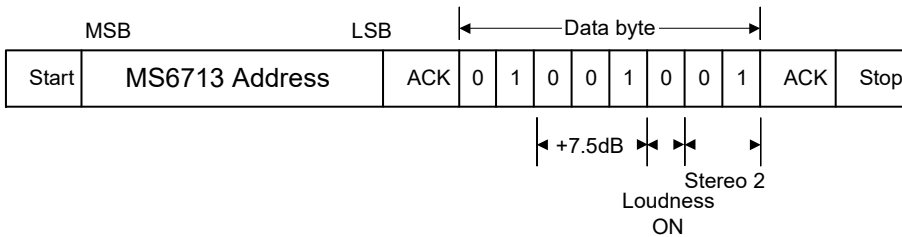

Set Treble at -10dB.

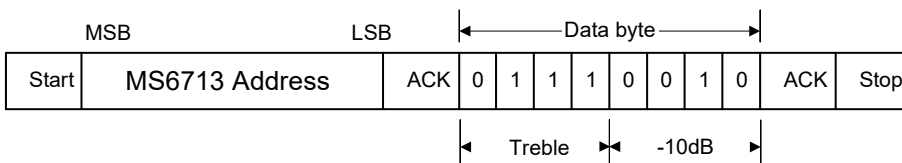

APPLICATION INFORMATION

Basic Application Example

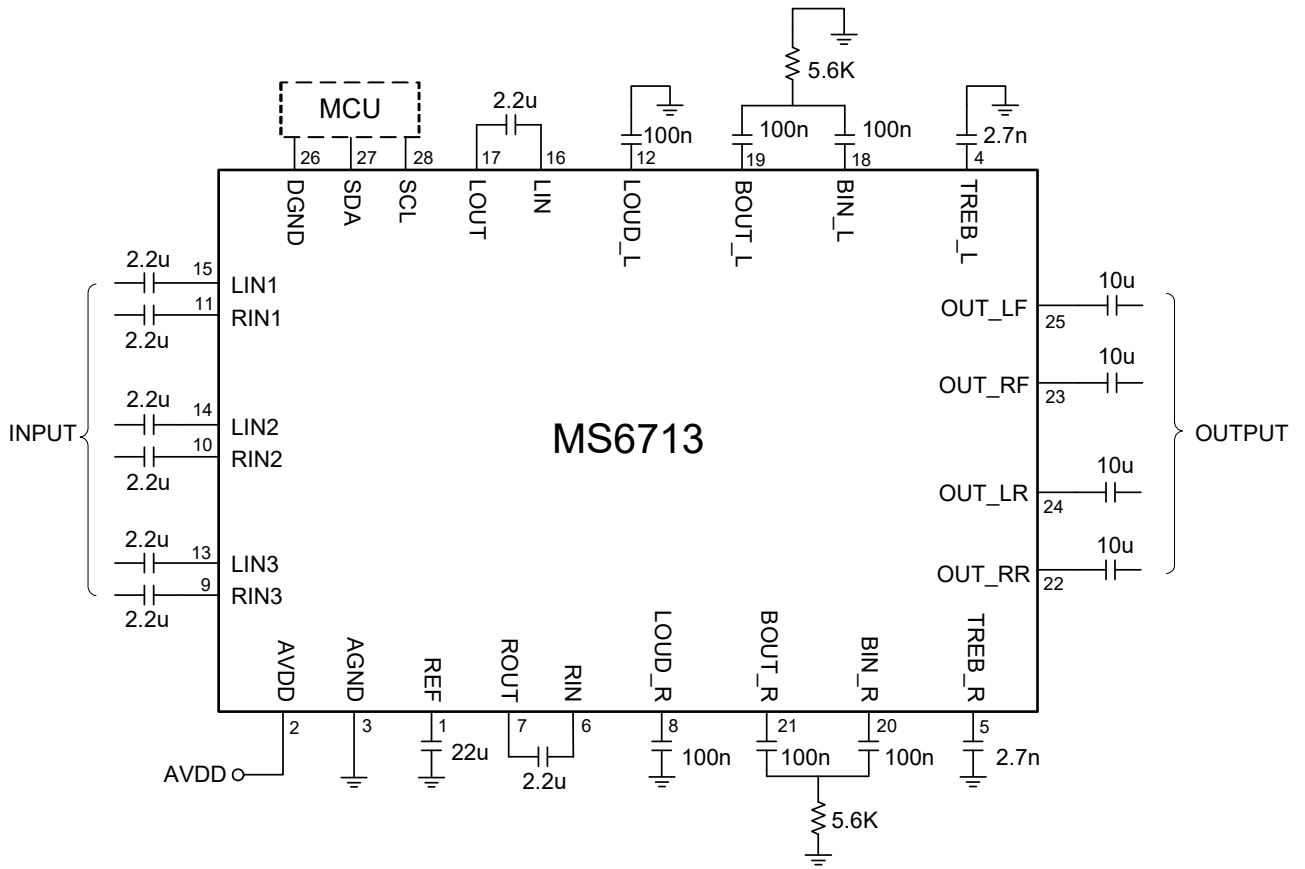

EXTERNAL DIMENSIONS

SSOP28

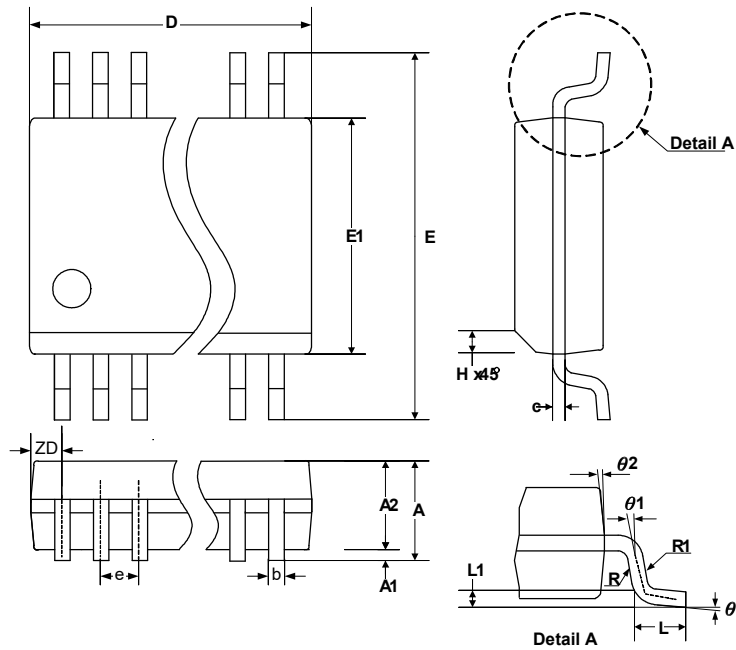

Symbol	Dimension in mm			Dimension in inch		
	Min	NOM	Max	Min	NOM	Max
A	1.35	1.63	1.75	0.053	0.064	0.069
A1	0.10	0.15	0.25	0.004	0.006	0.010
A2	-	-	1.50	-	-	0.059
b	0.20	-	0.30	0.008	-	0.012
c	0.18	-	0.25	0.007	-	0.010
e	0.635 BASIC			0.025 BASIC		
D	8.56	9.91	8.74	0.337	0.390	0.344
E	5.79	5.99	6.20	0.228	0.236	0.244
E1	3.81	3.91	3.99	0.150	0.154	0.157
L	0.41	0.635	1.27	0.016	0.025	0.050
h	0.25	-	0.50	0.010	-	0.020
ZD	0.838REF			0.033REF		
R1	0.20	-	0.33	0.008	-	0.013
R	0.20	-	-	0.008	-	-
θ	0°	-	8°	0°	-	8°
$\theta 1$	0°	-	-	-0°	-	-
$\theta 2$	5°	10°	15°	5°	10°	15°

DEMO BOARD

The demo board used IR technique controller to control the MS6713. The default states of demo board are Stereo 4, Input Gain 0dB, Volume -20dB, Attenuator Speakers 0dB, Loudness Off, Bass 0dB and Treble 0dB. The stereo 4 is connected internally, but not available on pins.

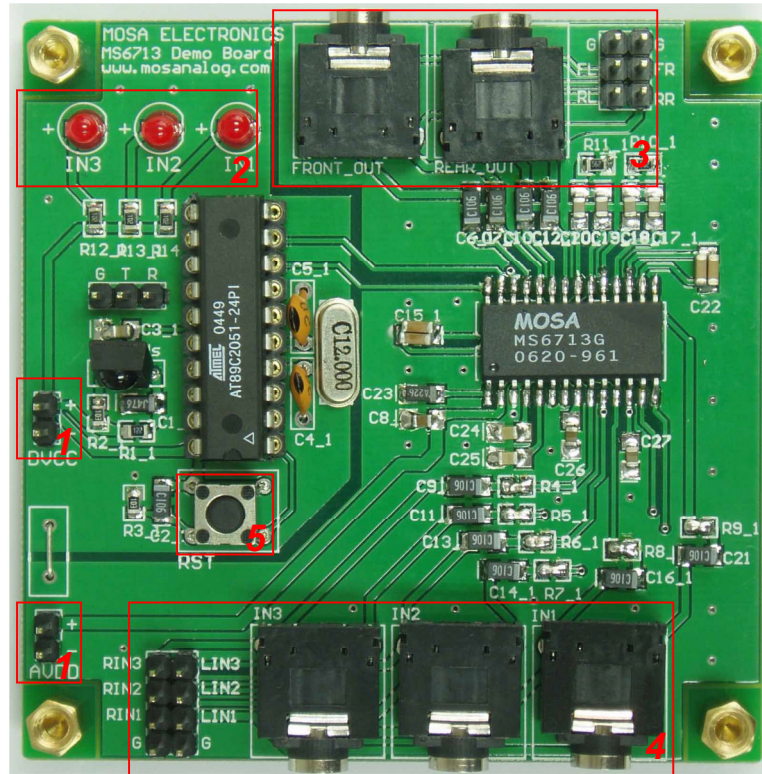

Label 1: Supply Voltage

The AVDD and DVDD should be the same supply voltage, the supply range is 2.7~6.5 VDC.

Label 2: LED Indicator

The LEDs indicate stereo input channel, IR received status and power status. It is red-dark blink once when the MCU has received the function code correctly.

Label 3: Output Section

There are four output channels in the section that divide into front output and rear output. Please connected to a post-power-amplifier, as active speaker.

Label 4: Input Section

There are three stereo inputs in the section. Please input stereo audio signal, as music or sine wave.

Label 5: MCU Reset

The MS6713 will be loaded the default values by MCU. The default states are Stereo 4, Input Gain 0dB, Volume -20dB, Attenuator Speakers 0dB, Loudness Off, Bass 0dB and Treble 0dB. The stereo 4 is connected internally, but not available on pins.

IR Controller

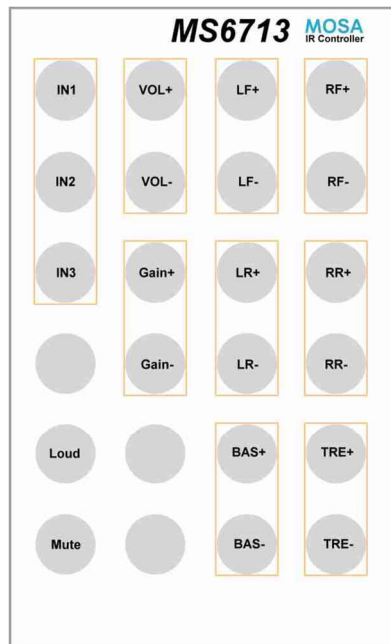

IN1, IN2, IN3 : Select Stereo Input.

IN1, 2, 3 represents Stereo Input 1, 2, 3. The active input will be indicated by the LEDs.

VOL+, VOL- : The volume control keys.

The volume control in 1.5dB/step as the switch is pressed once, the range is -79dB to 0dB.
LF-speaker , RF-speaker, LR-speaker, and RR-speaker are synchronic action.

Gain+, Gain- : The gain control keys for stereo input.

The gain control in 3.75dB/step as the switch is pressed once, the range is 0dB to 11.25dB.

LF+, LF- : The attenuation control keys for Left-Front speaker.

The attenuation in 1.25dB/step as the switch is pressed once, the range is -37.5dB to 0dB.

RF+, RF- : The attenuation control keys for Right-Front speaker.

The attenuation in 1.25dB/step as the switch is pressed once, the range is -37.5dB to 0dB.

LR+, LR- : The attenuation control keys for Left-Rear speaker.

The attenuation in 1.25dB/step as the switch is pressed once, the range is -37.5dB to 0dB.

RR+, RR- : The attenuation control keys for Right-Rear speaker.

The attenuation in 1.25dB/step as the switch is pressed once, the range is -37.5dB to 0dB.

TRE+, TRE- : The treble control keys.

The treble control in 2dB/step as the switch is pressed once, the range is -14dB to 14dB.

BAS+, BAS- : The bass control keys.

The bass control in 2dB/step as the switch is pressed once, the range is -14dB to 14dB.

Loud : The loudness key

Press the key once to set loudness on or loudness off.

Mute : The mute key controls all output speaker outputs

Press the key once to set mute-on or mute-off for four speaker outputs.

Circuit

