

# Mono 1.5W Power Amplifier

## Low Voltage Operation

### FEATURES

- Operation range: 2.5V ~ 6.5V
- Shutdown Current 0.1uA at 5V
- PSRR at 217Hz, 70dB at 5V
- Output power  
THD+N=10%  
 $R_L=8\Omega$ , 2.1W at 6V, 1.5W at 5V, 0.65W at 3.3V, 0.35W at 2.5V,  
THD+N=1%  
 $R_L=8\Omega$ , 1.75W at 6V, 1.2W at 5V, 0.5W at 3.3V, 0.25W at 2.5V  
THD+N = 0.2%  
 $R_L=8\Omega$ , 1.25W at 6V, 0.8W at 5V, 0.4W at 3.3V, 0.2W at 2.5V
- Unity-gain stable
- Space-saving SOP8(TP).

### APPLICATIONS

- Portable electronic devices
- PDAs
- Communication headsets

### Cross-reference

LM4890, LM4893, TS4890  
TPA751, MAX9716

### DESCRIPTION

The MS6890 is a low distortion power amplifier that can drive 1.5W of continuous average power into a mono 8Ω bridged-tied load (BTL). Operation with 2.5V supply, it can drive 0.2W into a mono 8Ω. The BTL configuration eliminates the need for external coupling capacitors on the output in most applications. The MS6890 is unity-gain stable and can be configured by external gain-setting resistors.

The MS6890 has good feature for portable equipment, these features include the low voltage operation, micropower consumption shutdown mode, enhance thermal pad small package SOP8(TP), make the MS6890 ideally suited for use in portable electronic equipments.

\*TP : Thermal Pad

### BLOCK DIAGRAM

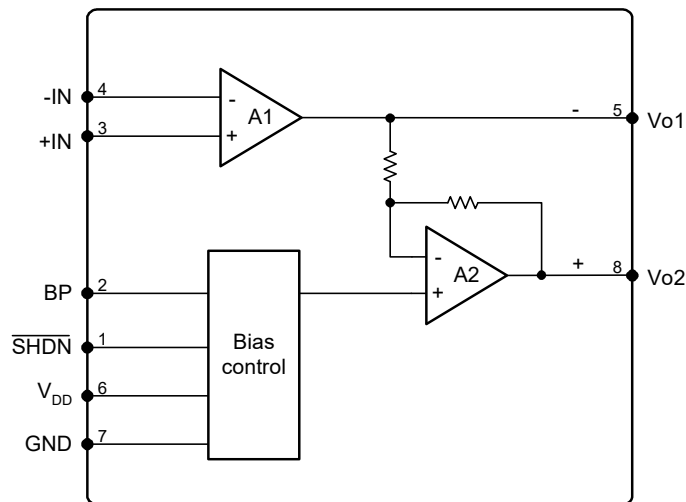

## PIN CONFIGURATION

Symbol	Pin	Description
/SHDN	1	/Shutdown places the entire device in shutdown mode when held low. TTL compatible input.
BP	2	Bypass is the cap to the voltage divider for internal mid-supply bias. This terminal should be connected to a 0.1- $\mu$ F to 10- $\mu$ F capacitor $C_{BP}$ .
+IN	3	Non-inverting input
-IN	4	Inverting input
Vo1	5	BTL negative output
V <sub>DD</sub>	6	Supply voltage
GND	7	Ground
Vo2	8	BTL positive output

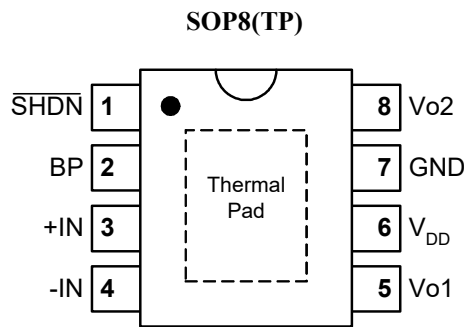

## ORDERING INFORMATION

Package	Part number	Packaging Marking	Transport Media
8-Pin SOP (lead free)	MS6890GTR	6890G	2.5k Units Tape and Reel
8-Pin SOP (lead free)	MS6890GU	6890G	100 Units Tube

RoHS Compliance

## ABSOLUTE MAXIMUM RATINGS

Symbol	Parameter	Rating	Unit
V <sub>DD</sub>	Supply voltage	6.5	V
V <sub>ESD</sub>	Electrostatic handling	3500	V
T <sub>STG</sub>	Storage temperature range	-65 to 150	°C
T <sub>A</sub>	Operating ambient temperature range	-40 to 85	°C
T <sub>J</sub>	Maximum junction temperature	150	°C
T <sub>S</sub>	Soldering temperature, 10 seconds	260	°C
R <sub>THJA</sub>	Thermal resistance from junction to ambient in free air SOP8(enhance thermal pad)	156.5	°C/W

## OPERATING RATINGS

Symbol	Parameter	Min	Typ	Max	Unit
V <sub>DD</sub>	Supply voltage	2.5	5	6.5	V

## 6V ELECTRICAL CHARACTERISTICS

T<sub>a</sub> = 25°C, V<sub>DD</sub>=6V, f=1kHz, BW<30kHz.

Symbol	Parameter	Conditions	Min	Typ	Max	Unit
I <sub>Q</sub>	Quiescent current	V <sub>IN</sub> =0V, I <sub>O</sub> =0A	-	3	-	mA
I <sub>SHDN</sub>	Shutdown current	V <sub>SHDN</sub> = GND	-	0.1	-	uA
V <sub>SDH</sub>	Shutdown input voltage high		2.0	-	-	V
V <sub>SDL</sub>	Shutdown input voltage low		-	-	0.8	V
PSRR	Power supply rejection ratio	R <sub>L</sub> =8Ω, C <sub>BP</sub> =10uF, f=217Hz	-	60	-	dB
THD+N	Total harmonic distortion plus noise	R <sub>L</sub> =8Ω, 1.25W	-	-55	-52	dB
				0.17	0.251	%
S/N	Signal-to-noise ratio	R <sub>L</sub> =8Ω, 1.25W	95	108	-	dB
P <sub>o</sub>	Output power	R <sub>L</sub> =8Ω, THD+N = 10%	-	2.1	-	W
		R <sub>L</sub> =8Ω, THD+N = 1%	-	1.75	-	W

## 5V ELECTRICAL CHARACTERISTICS

T<sub>a</sub> = 25°C, V<sub>DD</sub>=5V, f=1kHz, BW<30kHz, unless otherwise specified.

Symbol	Parameter	Conditions	Min	Typ	Max	Unit
I <sub>Q</sub>	Quiescent current	V <sub>IN</sub> =0V, I <sub>O</sub> =0A	-	2.7	-	mA
I <sub>SHDN</sub>	Shutdown current	V <sub>SHDN</sub> = GND	-	0.1	-	uA
V <sub>SDH</sub>	Shutdown input voltage high		2.0	-	-	V
V <sub>SDL</sub>	Shutdown input voltage low		-	-	0.8	V
PSRR	Power supply rejection ratio	R <sub>L</sub> =8Ω, C <sub>BP</sub> =10uF, f=217Hz	-	70	-	dB
THD+N	Total harmonic distortion plus noise	R <sub>L</sub> =8Ω, 0.8W	-	-55	-54	dB
				0.17	0.2	%
S/N	Signal-to-noise ratio	R <sub>L</sub> =8Ω, 0.8W	90	103	-	dB
P <sub>o</sub>	Output power	R <sub>L</sub> =8Ω, THD+N = 10%	-	1.5	-	W
		R <sub>L</sub> =8Ω, THD+N = 1%	-	1.2	-	W

### 3.3V ELECTRICAL CHARACTERISTICS

T<sub>a</sub> = 25°C, V<sub>DD</sub>=3.3V, f=1kHz, BW<30kHz, unless otherwise specified.

Symbol	Parameter	Conditions	Min	Typ	Max	Unit
I <sub>Q</sub>	Quiescent current	V <sub>IN</sub> =0V, I <sub>O</sub> =0A	-	2.3	-	mA
I <sub>SD</sub>	Shutdown current	V <sub>/SHDN</sub> = GND	-	0.1	-	uA
PSRR	Power supply rejection ratio	R <sub>L</sub> =8Ω, C <sub>BP</sub> =10uF, f=217Hz	-	75	-	dB
THD+N	Total harmonic distortion plus noise	R <sub>L</sub> =8Ω, 0.5W	-	-55	-54	dB
				0.17	0.2	%
S/N	Signal-to-noise ratio	R <sub>L</sub> =8Ω, 0.5W	90	100	-	dB
P <sub>o</sub>	Output power	R <sub>L</sub> =8Ω, THD+N = 10%	-	0.65	-	W
		R <sub>L</sub> =8Ω, THD+N = 1%	-	0.5	-	W

### 2.5V ELECTRICAL CHARACTERISTICS

T<sub>a</sub> = 25°C, V<sub>DD</sub>=2.5V, f=1kHz, BW<30kHz, unless otherwise specified.

Symbol	Parameter	Conditions	Min	Typ	Max	Unit
I <sub>Q</sub>	Quiescent current	V <sub>IN</sub> =0V, I <sub>O</sub> =0A	-	2.2	-	mA
I <sub>SD</sub>	Shutdown current	V <sub>/SHDN</sub> = GND	-	0.1	-	uA
PSRR	Power supply rejection ratio	R <sub>L</sub> =8Ω, C <sub>BP</sub> =10uF, f=217Hz	-	70	-	dB
THD+N	Total harmonic distortion plus noise	R <sub>L</sub> =8Ω, 0.2W	-	-55	-50	dB
				0.17	0.316	%
S/N	Signal-to-noise ratio	R <sub>L</sub> =8Ω, 0.2W	90	98	-	dB
P <sub>o</sub>	Output power	R <sub>L</sub> =8Ω, THD+N = 10%	-	0.35	-	W
		R <sub>L</sub> =8Ω, THD+N = 1%	-	0.25	-	W

## TYPICAL PERFORMANCE CHARACTERISTICS

Ta = 25°C, BW < 30kHz, unless otherwise specified.

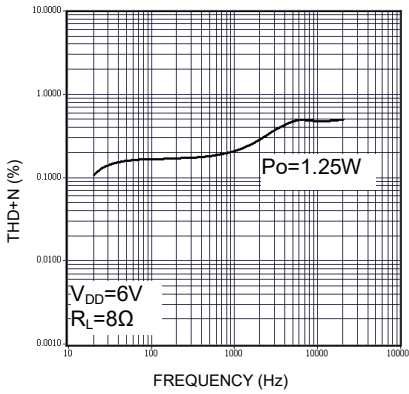

THD+N vs. frequency

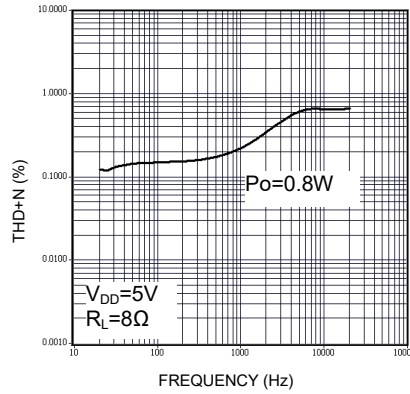

THD+N vs. frequency

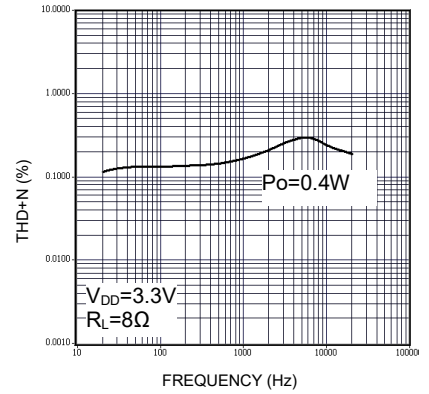

THD+N vs. frequency

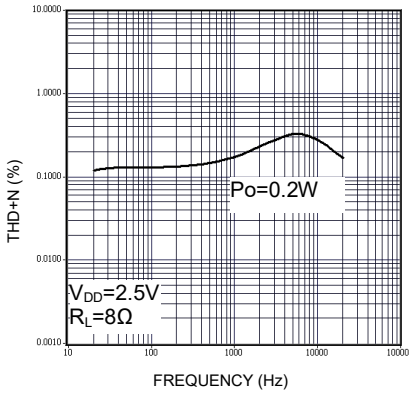

THD+N vs. frequency

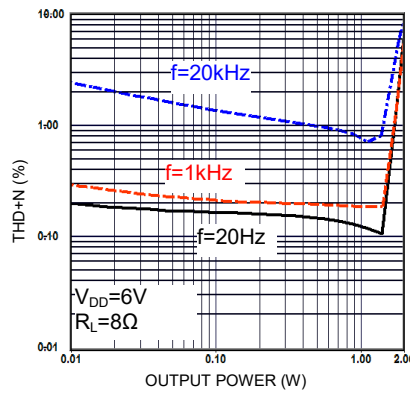

THD+N vs. output power

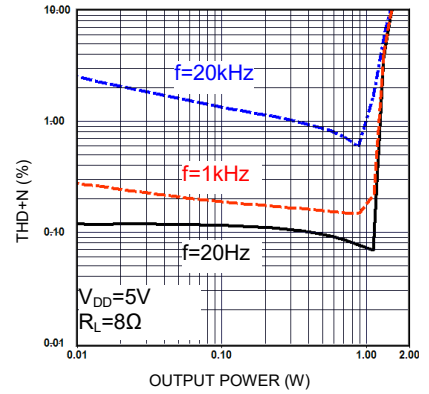

THD+N vs. output power

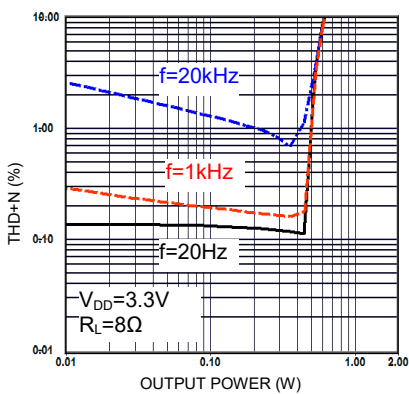

THD+N vs. output power

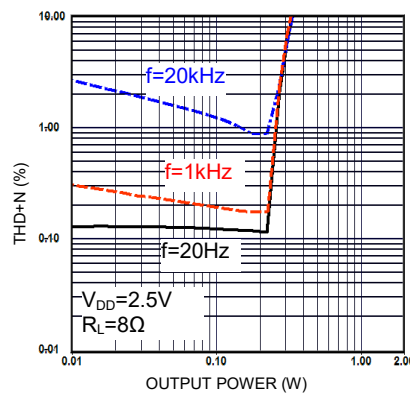

THD+N vs. output power

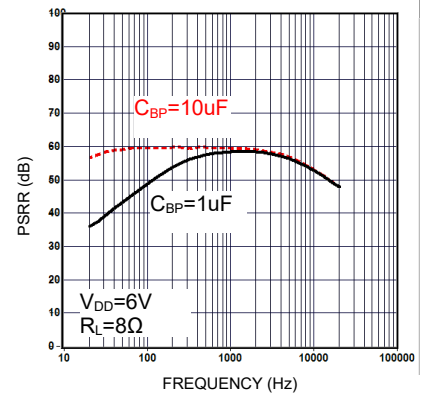

PSRR vs. frequency

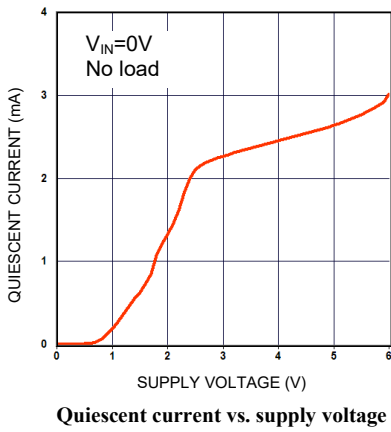
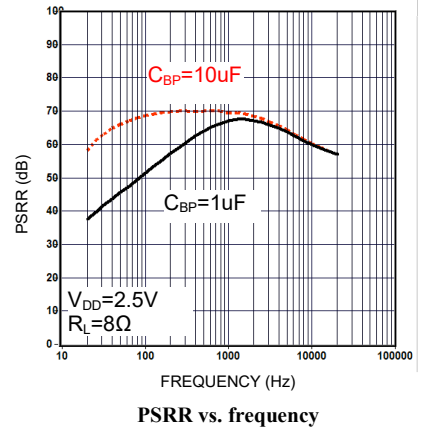
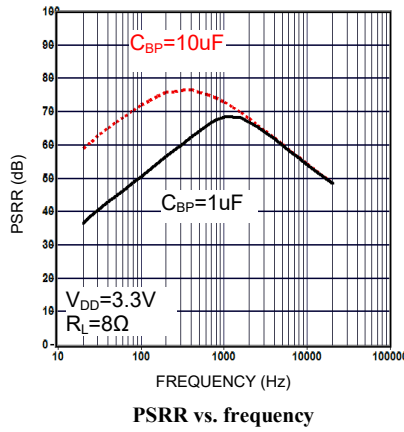
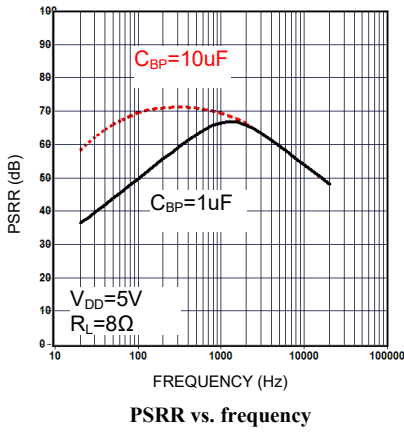

## APPLICATION INFORMATION

### Basic application example

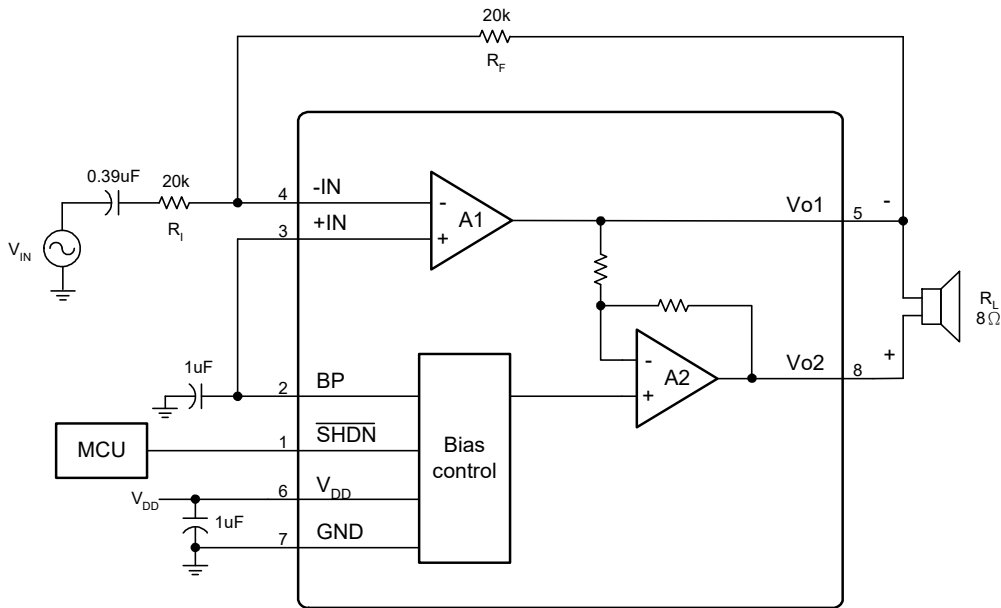

**Fig.1 A audio amplifier application circuit.**

### External gain-setting

As shown in Fig.1, The amplifier A1 is independent amplifiers with an externally configured gain of  $A_V = -R_F/R_I$ . The amplifier A2 is a closed-loop gain of  $A_V = -1$  fixed by two internal resistors. The outputs of A1 and A2 are used to drive the mono bridged-tied load (BTL).

### High Pass Filter

The input capacitor  $C_{IN}$  and resistor  $R_{IN}$  are decided the cut-off frequency of the HPF. The equation is as follows:

$$f_{\text{cut-off}} = 1 / (2 \pi * R_{IN} * C_{IN})$$

### Thermal pad considerations

The thermal pad must be connected to ground. The package with thermal pad of the MS6890 requires special attention on thermal design. The thermal pad on the bottom of the MS6890 should be soldered down to a copper pad on the circuit board. Heat can be conducted away from the thermal pad through the copper plane to ambient. If the copper plane is not on the top surface of the circuit board, 9 vias of 13 mil or smaller in diameter should be used to thermally couple the thermal pad to the bottom plane. For good thermal conduction, the vias must be plated through and solder filled.

## EXTERNAL DIMENSIONS

### SOP8 (Thermal Pad)

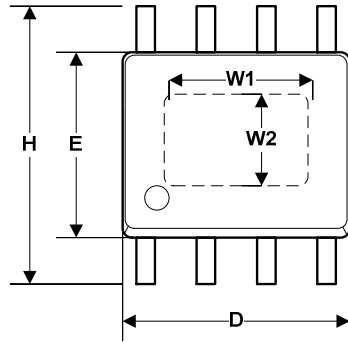

Symbol	Dimension in mm		Dimension in inch	
	Min	Max	Min	Max
A	1.35	1.75	0.0532	0.0688
A1	0.10	0.25	0.0040	0.0098
B	0.33	0.51	0.013	0.020
C	0.19	0.25	0.0075	0.0098
D	4.80	5.00	0.1890	0.1968
H	5.80	6.20	0.2284	0.2440
E	3.80	4.00	0.1497	0.1574
e	1.27 BSC		0.050 BSC	
L	0.40	1.27	0.016	0.050
W1	3.048	3.302	0.120	0.130
W2	2.159	2.413	0.085	0.095

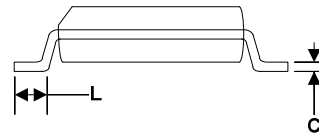
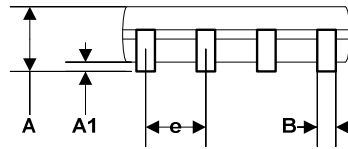

### TAPE AND REEL (Unit : mm)

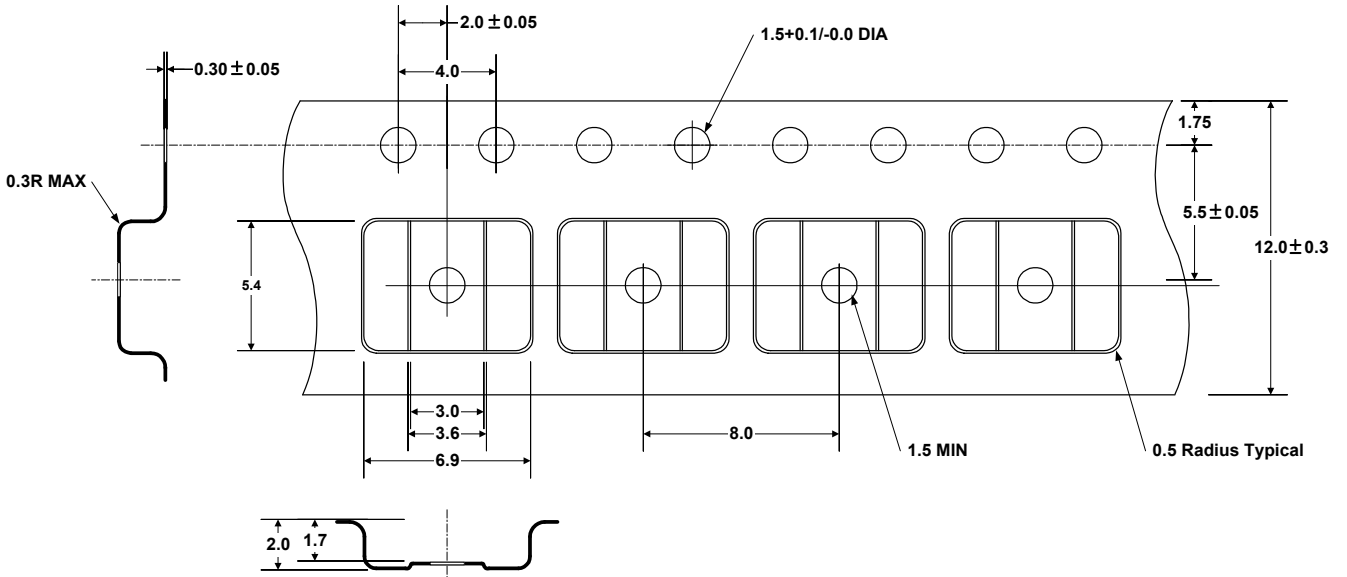

### SOP8



## DEMO BOARD

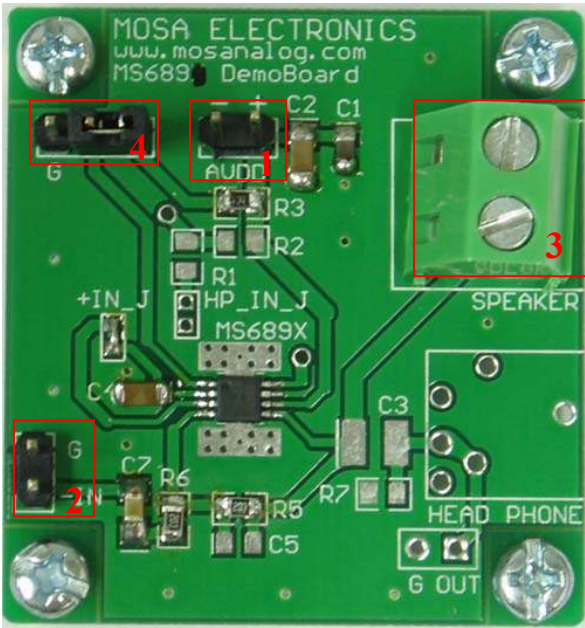

### Function description

Label 1: Supply Voltage

Supply voltage range is 2.5V to 6.5V, the left of jump is positive and the right of jump is negative.

Label 2: Signal Input

Connected to audio signals.

Label 3: Speaker Output

Connected to speaker with 8ohm or 4 ohm

Label 4: Shutdown Control

The system is active mode when the jump is placed left, the shutdown pin of MS6890 is connected to GND.

The system enters shutdown mode when the jump is placed right, the shutdown pin of MS6890 is connected to  $V_{DD}$ .

### Circuit

